













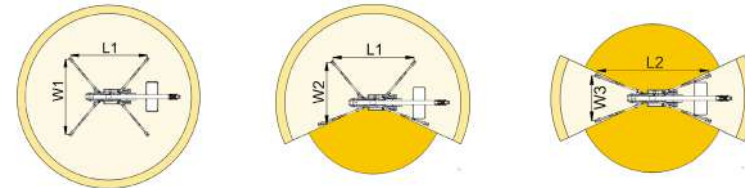







STANDARD EQUIP.



-  NON-MARKING TRACKS
-  ADDITIONAL AIR/WATER PIPES
-  RADIO CONTROL
-  PEDAL ON THE CAGE
-  RETURN TO HOME
-  PLASTIC PADS FOR OUTRIGGERS WITH STOP
-  PALCONTROL



37 ft 1 in	42 ft	21 ft 8 in	L1	L2	W1	W2	W3
550 lb	264 lb	264/550 lb	16 ft 4 in	21 ft 6 in	15 ft 11 in	12 ft 3 in	8 ft 7 in

															
TSJ 82/C		82 ft	42 ft	550 lb	660°	5 ft 11 in x 2 ft 4 in	90°+80°	8 ft 7 in x 15 ft 11 in	32%	36%	0,62 mi/h	8708 lb	5845 lb	34,19 psf	70,42 psf

BI-ENERGY

-  Diesel Kubota
14,7 kW
-  Single-phase electric motor
110 VAC - 1,1 kW





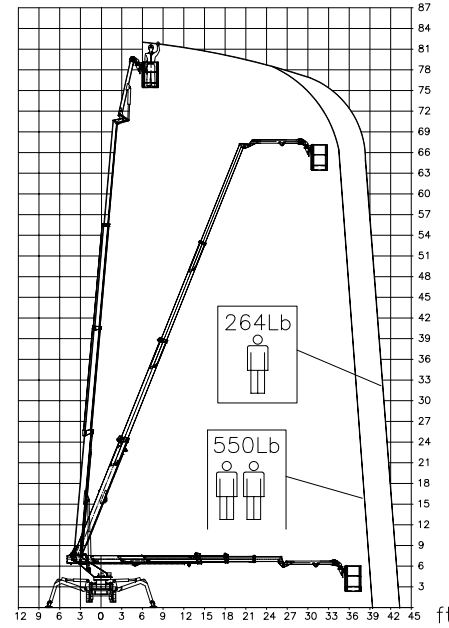
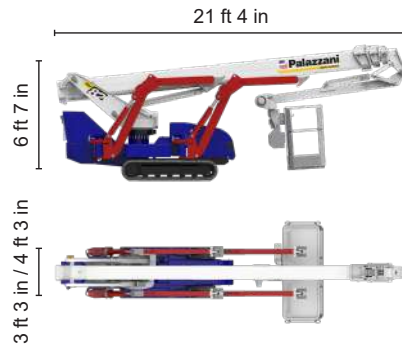

Palazzani North America Corp.
175 SW 7th St., Suite #1705, Miami, FL33130 US
Tel: +1 877-PALAZZANI
Mail: sales@palazzani-usa.com
www.palazzani-usa.com



The technical data may deviate +/- 3% from the specified values.
Characteristics and technical data are informative only and subjected to change without notice.







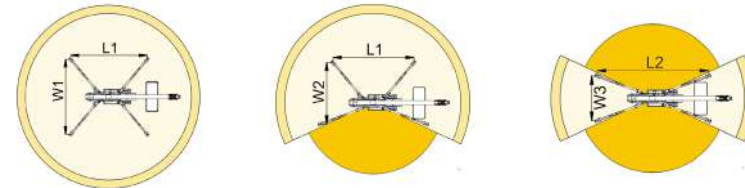









STANDARD EQUIP.



-  NON-MARKING TRACKS
-  ADDITIONAL AIR/WATER PIPES
-  RADIO CONTROL
-  PEDAL ON THE CAGE
-  RETURN TO HOME
-  PLASTIC PADS FOR OUTRIGGERS WITH STOP
-  PALCONTROL



37 ft 1 in	42 ft	21 ft 8 in	L1	L2	W1	W2	W3
550 lb	264 lb	264/550 lb	16 ft 4 in	21 ft 6 in	15 ft 11 in	12 ft 3 in	8 ft 7 in

															
TSJ 82/C		82 ft	42 ft	550 lb	660°	5 ft 11 in x 2 ft 4 in	90°+80°	8 ft 7 in x 15 ft 11 in	32%	36%	0,62 mph	8708 lb	5845 lb	34,19 psf	70,42 psf

ECO

-  Inverter actuated electric motor
-  Lithium iron phosphate battery LiFePO4







Palazzani North America Corp.
175 SW 7th St., Suite #1705, Miami, FL33130 US
Tel: +1 877-PALAZZANI
Mail: sales@palazzani-usa.com
www.palazzani-usa.com

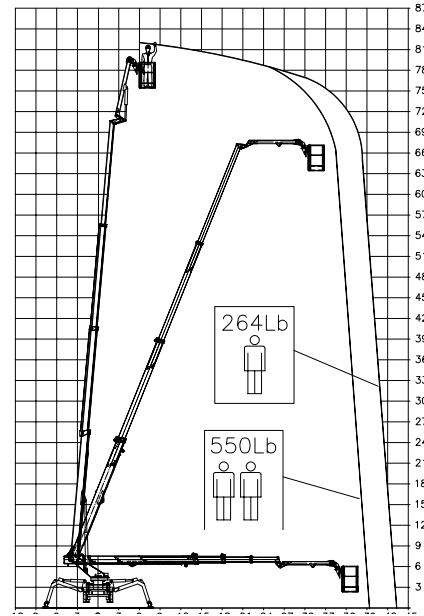
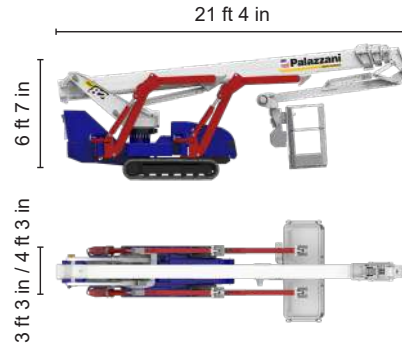

The technical data may deviate +/- 3% from the specified values.
Characteristics and technical data are informative only and subjected to change without notice.

STANDARD EQUIP.



-  NON-MARKING TRACKS
-  ADDITIONAL AIR/WATER PIPES
-  RADIO CONTROL
-  PEDAL ON THE CAGE
-  RETURN TO HOME
-  PLASTIC PADS FOR OUTRIGGERS WITH STOP
-  PALCONTROL

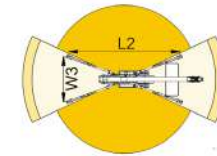
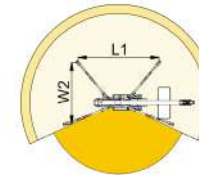
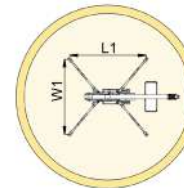



37 ft 1 in	42 ft	21 ft 8 in	L1	L2	W1	W2	W3
550 lb	264 lb	550/264 lb	16 ft 4 in	21 ft 6 in	15 ft 11 in	12 ft 3 in	8 ft 7 in



TSJ 82/C		82 ft	42 ft 8 in	550 lb	660°	5 ft 11 in x 2 ft 4 in	90°+80°	8 ft 7 in x 15 ft 11 in	32%	36%	0,75 mph	9557 lb	5845 lb	37,52 psf	77,28 psf
----------	---	-------	------------	--------	------	------------------------	---------	-------------------------	-----	-----	----------	---------	---------	-----------	-----------

HYBRID²

-  Diesel Kubota
10,6 kW
-  Inverter actuated electric motor
5,5 kW
-  Lithium iron phosphate battery LiFePO4
48 V - 210 Ah

Palazzani North America Corp.
175 SW 7th St., Suite #1705, Miami, FL33130 US
Tel: +1 877-PALAZZANI
Mail: sales@palazzani-usa.com
www.palazzani-usa.com



The technical data may deviate +/- 3% from the specified values.
Characteristics and technical data are informative only and subjected to change without notice.