















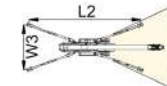
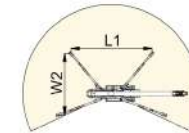
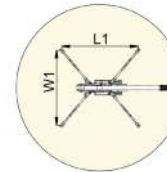







-  NON-MARKING TRACKS
-  ADDITIONAL AIR/WATER PIPES
-  RADIO CONTROL
-  PEDAL ON THE CAGE
-  RETURN TO HOME
-  PLASTIC PADS FOR OUTRIGGERS WITH STOP
-  PALCONTROL





		
<b>TSJ 82/C</b>		
77 ft 1 in	27 ft 11 in	1100 lb

<b>27 ft 11 in</b>	<b>L1</b>	<b>L2</b>	<b>W1</b>	<b>W2</b>	<b>W3</b>
1100 lb	16 ft 4 in	21 ft 6 in	15 ft 11 in	12 ft 3 in	8 ft 7 in

															
<b>TSJ 82/C</b>		82 ft	42 ft	550 lb	660°	5 ft 11 in x 2 ft 4 in	90°+80°	8 ft 7 in x 15 ft 11 in	32%	36%	0,62 mi/h	8708 lb	5845 lb	34,19 psf	70,42 psf

**BI-ENERGY**





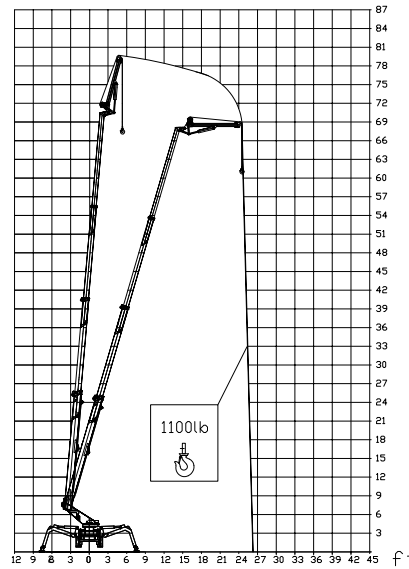
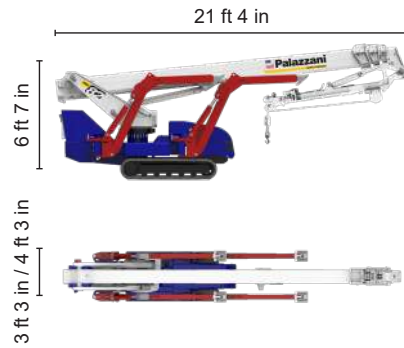

-  Diesel Kubota  
14,7 kW
-  Single-phase electric motor  
110 VAC - 1,1 kW

Palazzani North America Corp.  
175 SW 7th St., Suite #1705, Miami, FL33130 US  
Tel: +1 877-PALAZZANI  
Mail: sales@palazzani-usa.com  
www.palazzani-usa.com



The technical data may deviate +/- 3% from the specified values.  
Characteristics and technical data are informative only and subjected to change without notice.





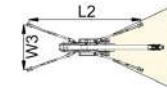
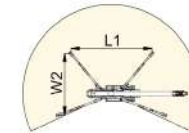
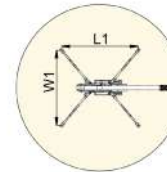











-  NON-MARKING TRACKS
-  ADDITIONAL AIR/WATER PIPES
-  RADIO CONTROL
-  PEDAL ON THE CAGE
-  RETURN TO HOME
-  PLASTIC PADS FOR OUTRIGGERS WITH STOP
-  PALCONTROL





		
<b>TSJ 82/C</b>		
77 ft 1 in	27 ft 11 in	1100 lb

<b>27 ft 11 in</b>	<b>L1</b>	<b>L2</b>	<b>W1</b>	<b>W2</b>	<b>W3</b>
1100 lb	16 ft 4 in	21 ft 6 in	15 ft 11 in	12 ft 3 in	8 ft 7 in

															
<b>TSJ 82/C</b>		82 ft	42 ft	550 lb	660°	5 ft 11 in x 2 ft 4 in	90°+80°	8 ft 7 in x 15 ft 11 in	32%	36%	0,62 mph	8708 lb	5845 lb	34,19 psf	70,42 psf

**ECO**





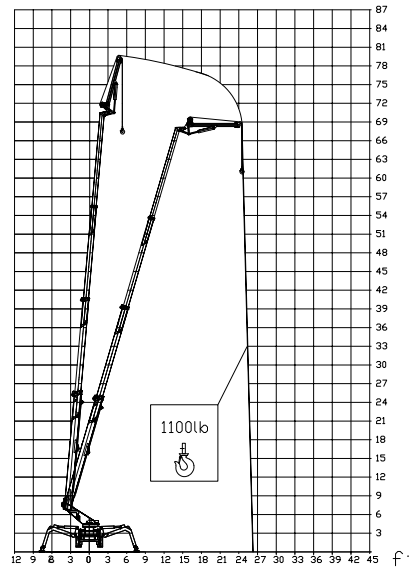
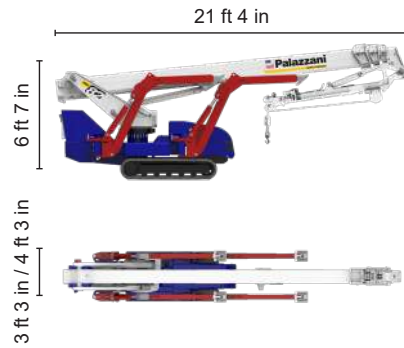

-  Inverter actuated electric motor
-  Lithium iron phosphate battery LiFePO4

Palazzani North America Corp.  
175 SW 7th St., Suite #1705, Miami, FL33130 US  
Tel: +1 877-PALAZZANI  
Mail: sales@palazzani-usa.com  
www.palazzani-usa.com



The technical data may deviate +/- 3% from the specified values.  
Characteristics and technical data are informative only and subjected to change without notice.





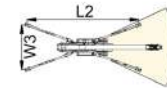
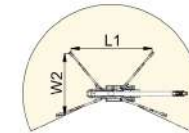
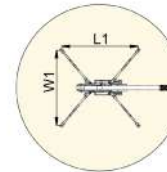











-  NON-MARKING TRACKS
-  ADDITIONAL AIR/WATER PIPES
-  RADIO CONTROL
-  PEDAL ON THE CAGE
-  RETURN TO HOME
-  PLASTIC PADS FOR OUTRIGGERS WITH STOP
-  PALCONTROL





		
<b>TSJ 82/C</b>		
77 ft 1 in	27 ft 11 in	1100 lb

27 ft 11 in	L1	L2	W1	W2	W3
1100 lb	16 ft 4 in	21 ft 6 in	15 ft 11 in	12 ft 3 in	8 ft 7 in

															
<b>TSJ 82/C</b>		82 ft	42 ft	550 lb	660°	5 ft 11 in x 2 ft 4 in	90°+80°	8 ft 7 in x 15 ft 11 in	32%	36%	0,75 mph	9557 lb	5845 lb	37,52 psf	77,28 psf

**HYBRID<sup>2</sup>**

-  Diesel Kubota  
10,6 kW
-  Inverter actuated electric motor  
5,5 kW
-  Lithium iron phosphate battery LiFePO4  
48 V - 210 Ah

Palazzani North America Corp.  
175 SW 7th St., Suite #1705, Miami, FL33130 US  
Tel: +1 877-PALAZZANI  
Mail: sales@palazzani-usa.com  
www.palazzani-usa.com



The technical data may deviate +/- 3% from the specified values.  
Characteristics and technical data are informative only and subjected to change without notice.